

信昌電子陶瓷股份有限公司  
Prosperity Dielectrics Co., Ltd.

SPECIFICATION FOR APPROVAL

DATE :

CUSTOMER : \_\_\_\_\_

PART NAME :           Metal Foil Type Power/Anti-Sulfur Free Current Sensing Resistors          

CUSTOMER'S DWG. NO. : \_\_\_\_\_

CUSTOMER'S PART NO. : \_\_\_\_\_

PDC PART NO. :           **FOF SERIES APPROVED**          

DESCRIPTION. : \_\_\_\_\_

ACTION RESULT	" V "	CUSTOMER'S SIGNATURE	NOTE
FULL APPROVED			
CONDITIONAL APPROVED			
REJECTED			

OUR ACTION	SIGNATURE
PREPARED By	<i>Jenny Tseng</i>
CHECKED By	<i>Tony Chou</i>
APPROVED By	<i>Byron Tsai</i>

CUSTOMER SIGNATURE FOR  
ACCEPTANCE

1. Features .....	2
2. Applications .....	2
3. Description .....	2
4. Mechanical Data .....	3
5. Recommended Solder Land Pattern .....	4
6. Marking .....	4
7. Functional Description .....	5
7.1 Derating curve .....	5
7.2 STORAGE CONDITIONS .....	5
7.3 SOLDERING CONDITIONS .....	5
8. Quick Reference Data.....	6
9. Part Number.....	6
10. Test & Requirements .....	7
11. PACKAGING .....	8
11.1 Tape Specifications.....	8
11.2 Reel Dimensions.....	8
11.3 Taping Quantity.....	8

## 1. Features

- Ultra low and stable TCR performance
- High power rating and compact size
- High reliability and stability
- Reduced size of final equipment
- RoHS exemption free & Lead free
- ASTM B-809 105C 1000hrs compliant

## 2. Applications

- Power supply
- PDA
- Digital meter
- Computer
- Automotives
- Battery charger
- DC-DC power converter

## 3. Description

The resistors are constructed in a high grade low resistive metal foil which adhere on top of ceramic substrate body. The resistive layer is covered with a protective coat and printed a resistance marking code over it. Finally, the two external end terminations are added. For ease of soldering the outer layer of these end terminations is a Lead free terminations.

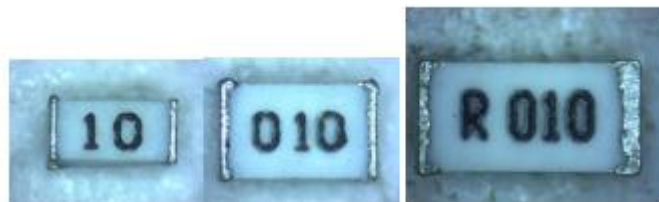
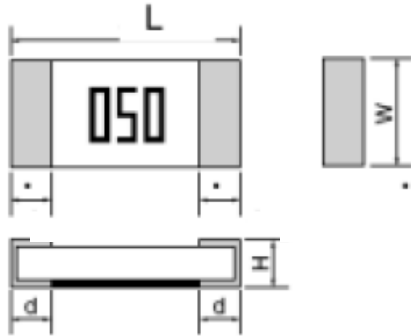

Fig 1. Construction of 0603/0805/1206

**4. Mechanical Data**



Type	Size (inch)	R-value	L (mm)	W (mm)	H (mm)	d (mm)
FOF25	2512	R002	6.4±0.30	3.2±0.30	0.65±0.20	2.8±0.30
		R003	6.4±0.30	3.2±0.30	0.65±0.20	2.6±0.30
		R004-R009	6.4±0.30	3.2±0.30	0.65±0.20	1.05±0.30
		R010-R049	6.4±0.30	3.2±0.30	0.65±0.20	1.05±0.30
		R050-R700	6.4±0.30	3.2±0.30	0.65±0.20	1.05±0.30
FOF06	1206	R003	3.3±0.20	1.7±0.20	0.65±0.20	1.20±0.30
		R004-R008	3.3±0.20	1.7±0.20	0.65±0.20	0.68±0.30
		R009-R049	3.3±0.20	1.7±0.20	0.65±0.20	0.68±0.30
		R050-R700	3.3±0.20	1.7±0.20	0.65±0.20	0.68±0.30
FOF05	0805	R003	2.10±0.20	1.35±0.20	0.65±0.20	0.65±0.20
		R004	2.10±0.20	1.35±0.20	0.65±0.20	0.50±0.20
		R005-R007	2.10±0.20	1.35±0.20	0.65±0.20	0.50±0.20
		R008-R049	2.10±0.20	1.35±0.20	0.65±0.20	0.50±0.20
		R050-R500	2.10±0.20	1.35±0.20	0.65±0.20	0.5±0.20
FOF03	0603	R005	1.7±0.20	0.9±0.20	0.65±0.20	0.50±0.20
		R006-R009	1.7±0.20	0.9±0.20	0.65±0.20	0.40±0.20
		R010-R049	1.7±0.20	0.9±0.20	0.65±0.20	0.40±0.20
		R050-R075	1.7±0.20	0.9±0.20	0.65±0.20	0.40±0.20
FOF02	0402	R005-R025	1.0±0.10	0.55±0.10	0.30±0.05	0.23±0.10

### 5. Recommended Solder Land Pattern

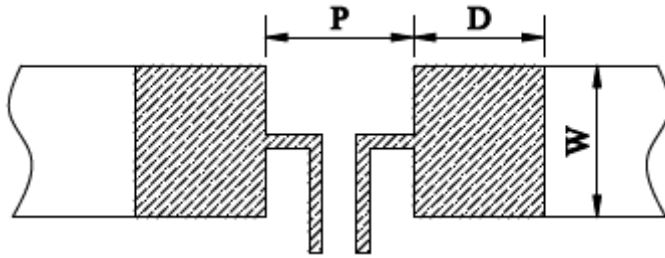

Type	R-value	P (mm)	W (mm)	D (mm)
FOF25	R002	0.60	3.57	4.35
	R003	0.90	3.57	4.20
	R004-R009	3.10	3.57	3.10
	R010-R700	3.10	3.57	3.10
FOF06	R003	0.60	1.84	2.10
	R004-R008	1.20	1.84	1.80
	R009-R700	1.20	1.84	1.80
FOF05	R003	0.50	1.44	1.55
	R004-R007	0.80	1.44	1.40
	R008-R500	0.80	1.44	1.40
FOF03	R005	0.50	0.92	1.35
	R006-R009	0.60	0.92	1.30
	R010-R075	0.60	0.92	1.30
FOF02	R005-R025	0.40	0.60	0.60

### 6. Marking

Each resistor is marked with a four-digits code on 2512/1206 & three-digits code on 0805 & two-digit on 0603 protective coating to designate the nominal resistance value. 0402 has no marking.

Example:

R020 = 0.02Ω ( FOF25/FOF06 )

020 = 0.02Ω ( FOF05 )

20 = 0.02 Ω ( FOF03 )

## 7. Functional Description

### 7.1 Derating curve

The power that the resistor can dissipate depends on the ambient temperature; see Fig.2

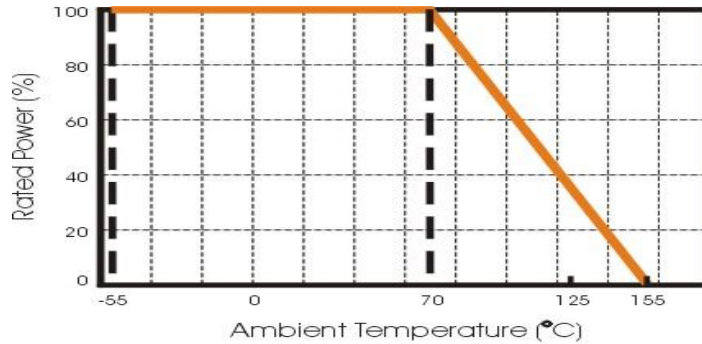

Fig.2 Maximum dissipation in percentage of rated power  
As a function of the ambient temperature

### 7.2 STORAGE CONDITIONS

Under airtight in temperature +10°C ~ 40°C 、relative humidity  $\leq 75\%$  can store 2 years.

Without dew in temperature +10°C ~ 60°C 、relative humidity be 95% maximum value for 30days.

### 7.3 SOLDERING CONDITIONS

The robust construction of chip resistors allows them to be completely immersed in a solder bath of 260°C for max.10 seconds. Therefore, it is possible to mount Surface Mount Resistors on one side of a PCB and other discrete components on the reverse (mixed PCBs).

Typical examples of soldering processes that provide reliable joints without any damage are given in Fig3 as below.

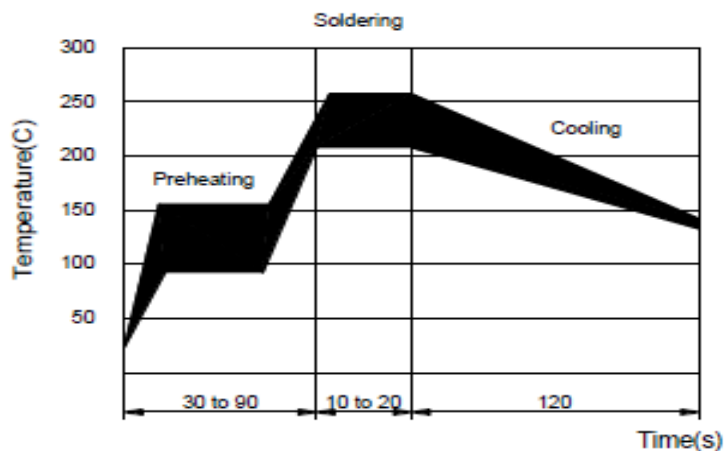

Fig 3. Infrared soldering profile for Chip Resistors

## 8. Quick Reference Data

Item	General Specification				
	FOF25	FOF06	FOF05	FOF03	FOF02
Series No.	FOF25	FOF06	FOF05	FOF03	FOF02
Size code	2512 (6432)	1206 (3216)	0805 (2012)	0603 (1608)	0402 (1005)
Resistance Tolerance	±5% , ±1%, ±0.5% (only for TC50)				
Resistance Range	2~450, 700 mΩ	3~700 mΩ	3~500 mΩ	5~75 mΩ	5~25 mΩ
TCR (ppm/°C)	2~9mΩ: ±100 10~700mΩ: ±50	3~9mΩ: ±100 10~700mΩ: ±50	3~9mΩ: ±100 10~500mΩ: ±50	5~9mΩ: ±100 10~75mΩ: ±50	5~25mΩ: ±100
Max. power at T <sub>amb</sub> =70°C	2W	1W	3/4W	1/2W	1/3W
Operation Temperature	-55 ~ +155°C				

Note : Max. Operation Current : So called RCWC (Rated Continuous Working Current) is determined by

$$RCWC = \sqrt{\text{Rated Power} / \text{Resistance Value}} \text{ listed above.}$$

## 9. Part Number

The resistors have a part number starting with .

Type	Size	Tolerance	Packing	Watt	R Code	TCR	Special Code
<b>FOF</b>	<b>02</b> :0402	<b>D</b> :±0.5%	<b>T</b> :Paper Tape	<b>E</b> : 1/3W	<b>XXXX</b>	<b>P</b> :	<b>SS</b> : Standard
	<b>03</b> :0603	<b>F</b> :±1%	5Kpcs	<b>F</b> : 1/2W	4 digits	50ppm	
	<b>05</b> :0805	<b>J</b> :±5%	<b>P</b> :Plastic Tape	<b>G</b> : 3/4W	R is first digit	<b>N</b> :	
	<b>06</b> :1206		4Kpcs (For 2512)	<b>H</b> : 1W	followed by 3	100ppm	
	<b>25</b> :2512			<b>J</b> : 2W	significant digits. 0.020R=R020 0.040R=R040		

Example :

### FOF25FPJR005NSS

→Metal foil, 2512 size, ±1%, plastic tape, 2W, 5mΩ, 100ppm

### FOF05FTGR020PSS

→Metal foil, 0805 size, ±1%, paper tape, 3/4W, 20mΩ, 50ppm

## 10. Test & Requirements

測試方法 Parameter	條件 Conditions	允收標準 Reuirements
瞬間過載測試 / Short Time Over Load	P= 2.5pr ; T=25±2°C, t = 5sec.	±(1.0%+0.5mΩ) IEC60115-1 4.13
高溫測試 / High Temp. Exposure	T = +170±2°C ; t = 1000h	±(1.0%+0.5mΩ) IEC60115-1 4.25
低溫測試 / Low Temp. Storage	T = +55±2°C ; t = 1000h	±(1.0%+0.5mΩ) IEC60115-1 4.25
濕度負載壽命測試 / Moisture Load Life ( 60°C、95%RH )	Vtest = Vmax ; T=60±2°C ; RH=95% ; t =90min ON, 30min OFF, 1000h	±(2.0%+0.5mΩ) IEC60115-1 4.25
冷熱衝擊測試 / Thermal Shock	[ -55°C 30min, →R.T. 3min, → -155°C 30min, →R.T. 3min,] 100 個連續循環 / 100Cycles	±(1.0%+0.5mΩ) IEC60115-1 4.19
在 70°C 下負載壽命測試 / Load Life at 70°C	Vtest = Vmax ; T=70±2°C ; t =90min ON, 30min OFF, 1000h	±(2.0%+0.5mΩ) IEC60115-1 4.25
可焊性測試 / Solderability	浸入錫爐 / Dip into solder at T = 245±5°C, t =3±0.5sec.	錫涵蓋面積/The covered area >95% IEC60115-1 4.17
抗焊熱性測試 / Resistance to Solder Heat	經熱風式迴焊爐 / Through Reflow T=275±5°C, t =20±1sec.	±(1.0%+0.5mΩ) IEC60115-1 4.18
機械衝擊測試 / Mechanical Shock	加速度 a =100G, 振幅時間 t =11ms, 5個衝擊 a=100G, t=11ms, 5 times shock	±(1.0%+0.5mΩ) IEC60115-1 4.21
基板彎曲測試 / Substrate bending	兩支撐點間距 / Span between fulcrums : 90mm ; 振幅 / Bend Width : 2mm ; 測試板/Test board : 玻璃纖維板/ Glass-Epoxy Board ; 厚度 / Thickness = 1.6mm	±(1.0%+0.5mΩ) IEC60115-1 4.33



## 11. PACKAGING

### 11.1 Tape Specifications (unit :mm)

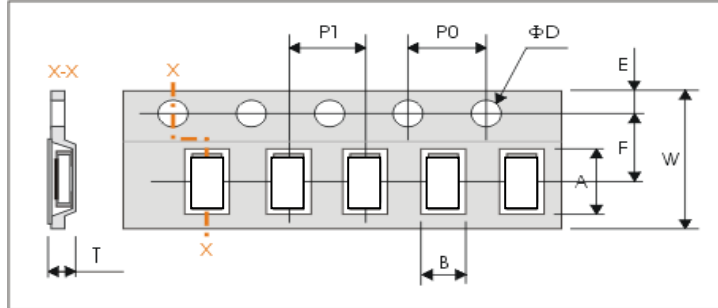

Symbol	A	B	W	F	E
FOF25	6.75±0.20	3.40±0.20	8.00±0.20	3.50±0.05	1.75±0.10
FOF06	3.65±0.20	2.05±0.20	8.00±0.20	3.50±0.05	1.75±0.10
FOF05	2.38±0.20	1.68±0.20	8.00±0.20	3.50±0.05	1.75±0.10
FOF03	1.98±0.20	1.18±0.20	8.00±0.20	3.50±0.05	1.75±0.10
FOF02	1.25±0.20	0.75±0.20	8.00±0.20	3.50±0.05	1.75±0.10
Symbol	P1	P0	ΦD	T	
FOF25	4.00±0.10	4.00±0.10	Φ1.50 <sup>+0.1</sup> <sub>-0.0</sub>	1.3 max.	
FOF06	4.00±0.10	4.00±0.10	Φ1.50 <sup>+0.1</sup> <sub>-0.0</sub>	1.0 max.	
FOF05	4.00±0.10	4.00±0.10	Φ1.50 <sup>+0.1</sup> <sub>-0.0</sub>	1.0 max.	
FOF03	4.00±0.10	4.00±0.10	Φ1.50 <sup>+0.1</sup> <sub>-0.0</sub>	1.0 max.	
FOF02	4.00±0.10	4.00±0.10	Φ1.50 <sup>+0.1</sup> <sub>-0.0</sub>	0.50±0.05	

### 11.2 Reel Dimensions

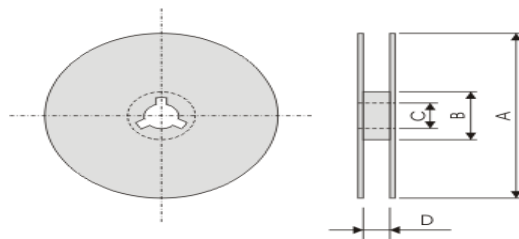

Symbol	A	B	C	D
(unit : mm)	Φ180.0 -1.5	Φ60.0±1.0	13.0±0.2	9.0 +1.0

### 11.3 Taping Quantity

0402 Reeled tape packaging : 8mm width paper taping 10,000pcs per reel.  
 1206/ 0805/ 0603 Reeled tape packaging : 8mm width paper taping 5,000pcs per reel.  
 2512 Reeled tape packaging : 8mm width PC taping 4,000pcs per reel.